

Meadow Voles and Pocket Gophers: Management in Lawns, Gardens, and Cropland

D. Gunn, R. Hirnyck, G. Shewmaker, S. Takatori, L. Ellis

Meadow voles and pocket gophers cause significant damage to rangeland, alfalfa, pastures, and other agricultural crops. Combined or alone, forage losses from gophers and/or voles have been estimated at 10 to 50 percent in pastures and alfalfa. These rodents also cause significant damage in orchards, nurseries, turf farms, ornamental flower plantings, landscapes, lawns, and vegetable gardens.

Both voles and gophers damage plants by eating roots, trunks, stems, tubers, and leaves. Their tunneling habits also cause damage. Large mounds of soil left by rodents, particularly gophers, can dull knives and discs on harvesting equipment. Soil from mounds also contaminates hay bales. Underground rodent burrows and tunnels interfere with irrigation practices and equipment. The burrowing and mounding capabilities of gophers encourage weed invasion through ground disturbance and can cause injury to people, horses, and livestock that step into holes.

Although voles reproduce more rapidly than gophers, both have remarkable reproductive capacity. Population surges can occur frequently when adequate forage and habitat are available.

Voles and gophers are considered non-game mammals in most states and can be legally managed on private property and public lands. Check with your state wildlife

agency or department of agriculture regarding legal control methods in your area. Management options depend on the pest, the situation, cost limitations, and equipment and labor availability. It is important to understand the target pest's biology and habits before implementing management strategies.

Figure 1. Vole (meadow mouse). Photo by Danielle Gunn.



Figure 2. Vole (meadow mouse). Photo by Danielle Gunn.



Voles

Vole biology

Several species of voles exist in the Pacific Northwest, and it can be difficult to distinguish among them. The meadow vole, or meadow mouse (*Microtus pennsylvanicus*), is the most common species in pastures, rangelands, crops, and lawns. Meadow voles are heavy-bodied, small rodents with short legs and tails; small, rounded ears; and coarse, blackish to grayish brown fur with black-tipped hairs and bicolored tails. When fully grown, voles generally average 4½ to 5½ inches long, including the tail (Figures 1 and 2). Under good weather and feeding conditions, voles can reach 7⅝ inches in length.

Voles can reproduce year-round, with a peak breeding period in the spring followed by a second, smaller breeding period in the fall. Females can reach reproductive maturity in 35 to 40 days. They average one to five litters per year, with three to six young per litter. Gestation length is approximately 21 days.

Vole populations are cyclic and can fluctuate dramatically from year to year. During most years, voles are not a significant problem, and populations are partially controlled by predators such as snakes, coyotes, foxes, hawks, owls, and domestic cats.

If habitat is abundant and provides adequate protection from predators, weather conditions are ideal, and high-protein food sources exist, vole populations can quickly reach damaging levels. Minor peak populations occur approximately every 4 to 6 years, and epidemic populations occur about every 10 to 12 years. However, these cycles are not regular. Population explosions last about a year before the population crashes. Population explosions can result in significant economic and aesthetic losses.

Very few references document the cost of vole damage in field crops and nursery stock due to the cyclic nature of vole populations and the potential for explosive epidemics. Economic losses can be severe, but are often not quantified.

Vole behavior

Most damage caused by voles is the result of feeding activity. Voles weigh 3 to 4½ oz and can eat nearly their own body weight daily. Voles damage crops by feeding on roots and stems, grass, seeds, and underground reproductive structures such as bulbs and tubers. They damage and kill trees and shrubs

by girdling and removing the bark from the trunk or stems near the base (Figure 3). Damage to trees and shrubs normally occurs in the winter when voles are foraging under snow cover.



Figure 3. Bark removed by a vole. Photo by Bill Lord, University of New Hampshire Cooperative Extension Specialist Emeritus. Reproduced by permission from UNH Extension.

Voles do not hibernate. They are active year-round, but are most active in the spring and fall. They are most active at night, but can also be seen during the day.

Voles are normally found in areas of dense ground cover. Vegetation greater than 6 inches in height, snow cover, brush piles, leaves, and low-hanging tree limbs provide protection from predators. Rangeland, alfalfa and grass hayfields, pasture, orchards, and home lawns and gardens provide ideal habitat and food sources for these pests.

Voles do not like crossing bare ground and prefer cover when feeding. Feeding activity can be easily recognized by the presence of shallow tunnels and runways in vegetation and by underground nests of grass, stems, and leaves. Runways are approximately 1 to 2 inches wide, with an entrance hole leading underground (Figures 4 and 5). Around frequently used runways, grass and other vegetation may be clipped very close to the ground. Feces and small pieces of clipped vegetation are usually found in runways. Voles seldom stray from their usual travel routes.

Figure 4. Example of vole infestation: feeding area, runways, and entry hole. Photo by Danielle Gunn.

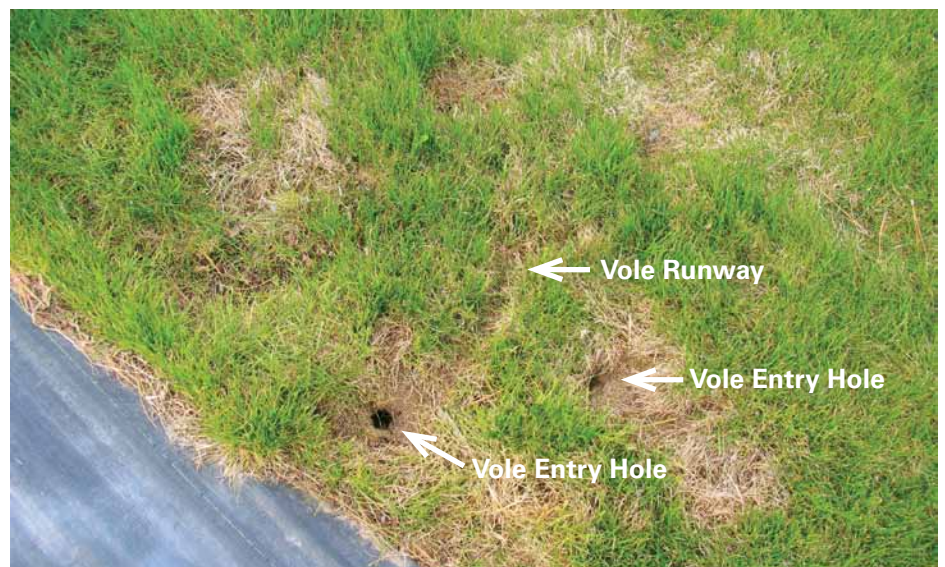

Table 1. Meadow vole management options.

Control method	Rodenticide	Legal constraints*	Timing	Comments
Habitat modification	n/a	n/a	Early spring through late fall	Mow, graze, or burn vegetation. Remove weeds and other debris.
Exclusions: 3/8-inch netted wire extending 6 inches below and above desired vegetation.	n/a	n/a	Year-round	Excellent for protecting trees, shrubs, and flowers.
Trapping	n/a	Trapping is not legal in Washington. May be used only in Idaho and Oregon.	Anytime	Begin in early spring. Place traps at right angles in surface runways.
Hand and mechanical baiting	Zinc phosphide	Check individual product labels; some allow use on cropland. Some formulations are restricted-use products. Oregon has additional restrictions on zinc phosphide use.	Early spring through late fall	Apply by hand or mechanically. Bait stations are useful for larger populations. Do not apply when moisture is anticipated.
	General-use anticoagulants: chlorophacinone, warfarin	Available for purchase and use without an applicator license. For noncrop use only. Generally for use around homes and buildings.	Anytime	Requires multiple applications.
	Restricted-use anticoagulants: Diphacinone (Ramik Brown, Kaput-D) and chlorophacinone (Rozol Vole Bait)	A pesticide applicator license is required to purchase and apply these products. For use in orchards, nurseries, turf, lawn, golf courses, tree and forestry plantations, and other noncrop areas. May be applied to dormant alfalfa.	Early spring through late fall	Requires multiple applications.

*Pesticide license requirements for baits and fumigants: Note that some baits and all aluminum phosphide fumigants are restricted-use pesticides (RUP) and can be purchased and applied only by a licensed pesticide applicator. Oregon has additional restrictions on zinc phosphide use. Contact your state department of agriculture for more information concerning pesticide licensing for rodent control.



Figure 5. Vole runway. Photo by Danielle Gunn.

Vole management

Where voles are likely to be a problem, routinely monitor for signs of feeding activity from early spring until late fall. Runways, clipped forage, gnawed stems, bark, and roots are signs of possible vole activity.

Table 1 provides a summary of various measures to help manage damaging vole populations.

Habitat modification

Habitat modification and/or population reduction strategies can prevent large population increases. Methods include the following:

- Mowing or burning ditch banks, barrow pits, and fence lines

- Clearing weeds and debris from windbreaks and other affected areas
- If practical, developing weed-free cultivated buffer strips around cropland. For large acreages, this is an effective method.
- Grazing or mowing alfalfa and pasture in the late fall when plants are not actively growing
- Light tillage of field perimeters and fields
- Aluminum flashing or other materials constructed around areas of concern to serve as entry barriers

Plant protection

You can protect trees, shrubs, and flower beds by surrounding plants with netted wire. Install $\frac{3}{8}$ -inch netted wire from approximately 6 inches below soil level to approximately 6 inches above ground.

Trapping

In Idaho and Oregon, homeowners with small infestations can trap voles with wooden mousetraps. Trap placement is crucial for optimum success. Place traps flush with



Figure 6. Proper trap placement using a right angle to intercept voles using runways. (Note: Trapping is legal only in Idaho and Oregon, not in Washington.) Photo by Danielle Gunn.

Note: Trapping is not allowed in Washington State. Residents in Washington cannot utilize trapping to manage vole populations.

the ground and at a right angle to surface runways (Figure 6). Use a small chain to attach the trap to a stake to prevent raptors or other predators from dragging away the vole and trap.

Bait is generally not needed because voles will trip traps during normal activity. If desired, traps can be baited with peanut butter, oatmeal, or apple slices. Voles occasionally learn to take bait without tripping the trap. To avoid bait loss, mix peanut butter with cotton wool or cotton balls and clamp the cotton into the tripping mechanism of the trap.

Examine traps daily and remove and bury dead voles. Like all rodents, voles can carry diseases, bacteria, and other organisms that can be harmful to humans, so do not handle voles without gloves.

Trapping is best utilized in small areas, such as lawns, and is not effective or practical for large infestations.

Baiting

Toxic bait can successfully control voles in gardens, turf, rangeland, and cropland perimeters. Many of these baits must be placed in bait stations. Figure 7 illustrates a simple PVC pipe bait station. The plywood cover provides protection from predators or raptors, keeps bait dry so it does not lose effectiveness, and prevents access by children, birds, pets, and other animals. Although Figure 7 suggests a quarter sheet of plywood, any sturdy covering, such as a tarp, canvas, or metal roofing material will suffice.

Do not apply bait when moisture is anticipated. Place bait stations in runways or next to burrows so voles will find them while traveling their normal routes. Bait stations can be prebaited with vegetables and peanut butter to attract voles, but this practice generally is not necessary unless voles are not consuming bait. If voles are not consuming bait products, prebaiting with nontoxic bait that is the same size, shape, and formulation as the toxic bait may increase consumption. Once voles are used to consuming the nontoxic bait on a regular basis, change to the toxic bait.

Always use fresh bait products. Old bait products may have an off odor or could be moldy or damaged and not effective.

When using bait stations in turf, place them on the edges of turf where the most activity is apparent. Move bait stations regularly so that turf under the cover is not significantly damaged.

For range and pastures, bait can be placed around field perimeters. Lengthen the feeding tube to at least 12 inches and stake the bait station to the ground. The longer tube holds more bait since these stations cannot be monitored as often as those in lawns and gardens. The longer tube also reduces bait spillage. In these areas, bait stations do not need to be covered, since pets and children are not likely to be present and good vegetative cover will encourage voles to visit. However, if safety is a concern, use a durable covering over the bait station. The cover will prevent non-target poisoning and deter other animals from damaging the bait station.

Carefully read and follow all label instructions when applying bait. Use caution when applying baits where children, pets, and other

Materials Needed:

- 3 - 2" PVC pipe cut to 8" lengths
- 3 - 2" PVC pipe end caps (two partially cut, see diagram)
- 1 - 2" T-connection for PVC pipe
- 1 - 1/2" metal stake (rebar works)
- 1 - Hose clamp
- PVC pipe prep and cement
- 1/4 sheet of plywood or smaller

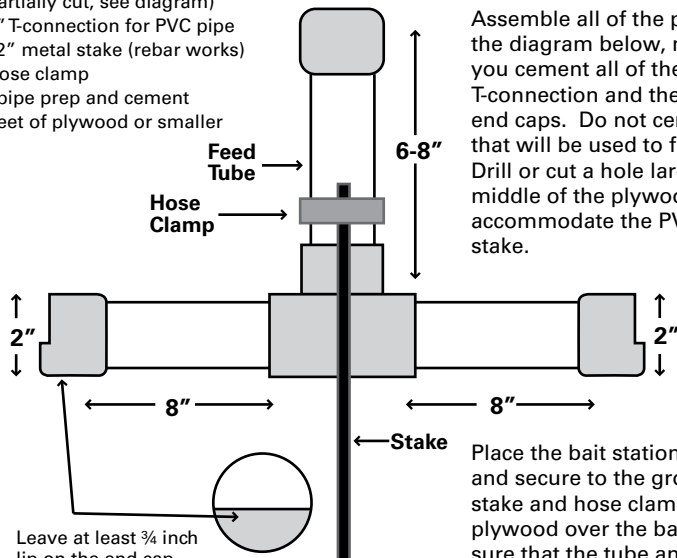

Leave at least 3/4 inch lip on the end cap - this will prevent the bait from spilling out of the bait tube.

Instructions:

Assemble all of the pieces as seen in the diagram below, making sure that you cement all of the pipes to the T-connection and the two partially cut end caps. Do not cement the end cap that will be used to fill the bait station. Drill or cut a hole larger than 2" in the middle of the plywood. The hole must accommodate the PVC pipe and the stake.

Place the bait station in a vole runway and secure to the ground using the stake and hose clamp. Place the plywood over the bait station making sure that the tube and stake fit through the hole. Fill the feed tube with bait and place end cap on top. Place weight such as bricks on top of the plywood to make sure larger animals cannot get access to the bait.

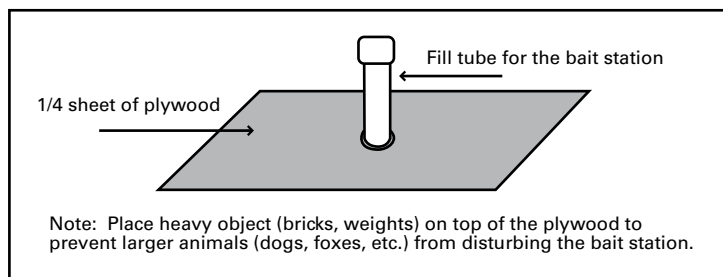

Figure 7. Bait station construction. Diagrams by Sherman Takatori.

non-target animals are likely to be present. Dispose of dead voles and bait that may spill from the trap so there is no chance of poisoning pets, livestock, or wildlife.

Zinc phosphide baits: Zinc phosphide is sold under trade names such as Prozap and ZP AG. Some zinc phosphide products are combined with grains, while others are in pellet form.

Some zinc phosphide products are restricted-use pesticides and require a pesticide applicator license to purchase and use. These products include those labeled for agricultural crops such as wheat, barley, alfalfa,

potatoes, sugar beets, grape vineyards, orchards, and nursery stock. These products can be broadcast on the target site. Before purchasing, check the label to be sure the product can be used on the target crop.

Other zinc phosphide products are general-use pesticides and do not require a pesticide applicator license. These products can be used in turf, lawns, and other non-crop areas. They can be placed in runways, in or next to burrows, or mechanically broadcast in infested areas. In many areas, spreaders are available for rental from farm or garden supply stores. However, it is always a good practice to place zinc phosphide in a bait station to keep it out of reach of children and non-target animals.

Be sure to keep zinc phosphide from getting wet. Moisture activates the chemical, rendering it ineffective very quickly.

Zinc phosphide acts rapidly, and a single feeding is generally lethal to voles within 12 hours. In rare cases, voles may survive and become bait shy. For this reason, zinc phosphide should not be used in the same field more than once in a 6-month period.

Zinc phosphide converts to phosphine gas when it is ingested by a vole, causing death. It does not accumulate in the vole's body tissues. Therefore, predators or scavengers such as dogs or cats are not likely to be affected by eating poisoned rodents. However, children, pets, birds, and other animals can be

Oregon restrictions on zinc phosphide use

In order to prevent exposure to geese from zinc phosphide applied on grass grown for seed, Oregon has issued Special Local Need (SLN) registrations with specific application restrictions and timing of applications. Additionally, there are several other Oregon SLN labels for zinc phosphide use that prohibit any use in Gilliam, Morrow, and Umatilla counties. Some Oregon SLN labels restrict uses to below-ground applications only. Be sure to check with the Oregon Department of Agriculture or their website ([http://www.oregon.gov/ODA/ODA/PEST/index.shtml](http://www.oregon.gov/ODA/PEST/index.shtml)) before purchasing or applying any zinc phosphide in Oregon, and read and follow all zinc phosphide use directions on the Oregon SLN labels.

Additional cautions regarding rodenticide use

Rodenticide baits may pose a hazard to federally designated endangered and/or threatened species and may not be used in any manner that results in harm or death of these species. It is the responsibility of the pesticide applicator to perform any application correctly so that it will not harm and/or kill any threatened and/or endangered species. Always follow the rodenticide (pesticide) label directions, especially the “Environmental Hazards” section of the label. The label may contain additional web-distributed information that will be the responsibility of the pesticide applicator to obtain and follow. If you have any questions or concerns regarding species that may be affected by the application, contact your local extension office, state department of agriculture, or local fish and wildlife agency.

Rodenticide (pesticide) labels and uses are constantly changing. Specific product names and rates are not provided in this publication, due to the nature of changing labels and product availability. The following websites may be useful for checking on locally registered rodenticide products. Be sure you select a product that is allowed for your application site and target rodent pest.

- In Idaho, the University of Idaho Pest Management Center maintains an annually updated table of rodenticides labeled for use to control meadow voles and pocket gophers in a variety of sites. The web address is <http://www.uhome.uidaho.edu/ipm>.
- In Oregon and Washington, a searchable pesticide database, Pesticide Information Center Online (PICOL), is available online at <http://cru66.cahe.wsu.edu/LabelTolerance.html>. This is a very detailed search engine and requires some additional knowledge. It is recommended that you seek advice from extension personnel the first time you access information from PICOL.
- In Oregon, also be sure to check the Oregon Department of Agriculture website for a list of zinc phosphide SLN registrations: http://oda.state.or.us/dbs/pest_productsL2K/search.lasso

affected by direct contact with the bait. Store bait out of reach and use it carefully to minimize unintended access.

Anticoagulant baits: Anticoagulants require multiple feedings by the rodent before a lethal dose is ingested. Anticoagulant baits are formulated using grain or other food sources that will attract rodents. These baits are usually in the form of pellets and blocks, and some are coated in paraffin to provide moisture resistance. Paraffin-coated baits

are useful around ditches and other areas where moisture may cause other types of baits to spoil and lose potency.

Anticoagulant baits cannot be applied directly to food or feed crops. To avoid contact with a growing crop, these baits are used in areas adjacent to crop fields or during crop dormancy. Before purchasing any product, check the label to be sure it can be used on the target site.

Diphacinone bait products (Ramik Brown and Kaput-D) are restricted-use pesticides available only to those who have a current pesticide applicator license. These products can be used in fruit and nut orchards, tree nurseries, and tree farms, but cannot be applied directly to food or feed crops.

Another restricted-use pesticide is Rozol Vole Bait (chlorophacinone). It can be used in noncrop areas, lawns, turf, ornamental flower and shrub plantings, orchards, nurseries, and tree and forestry plantations.

General-use anticoagulant pesticides include another formulation of chlorophacinone (Rozol pellets) and warfarin (Kaput, Rodex). These products can be used by the general public. They are intended for use around homes and buildings.

All anticoagulant baits are toxic to other animals, so take precautions to prevent nontarget animals from consuming the bait. Carefully read and follow the precautionary statements on the pesticide label. Bait must be used at the specific target site as indicated on the label.

Predators

Owls, hawks, snakes, cats, dogs, and other predators utilize voles as a food source. However, predators alone will not eliminate damage to fields, rangeland, trees, or lawns, and often do not keep vole populations at an acceptable level.

Pocket gophers

Pocket gopher biology

Pocket gophers (Figure 8) are one of the most prevalent and destructive vertebrate pests in the Pacific Northwest. There are three genera of pocket gophers in the United States, *Thomomys*, *Geomys*, and *Pappogeomys*, representing 18 different species. Genus classification is based on the size of the forefeet, claws, and front surfaces of the incisors.

Identification of species can be difficult. Generally, only one species is found in a defined area.

Pocket gophers are burrowing rodents that get their name from the fur-lined, external cheek pouches they use for carrying food and nesting materials. Pouches are located outside the mouth on both sides of the face. Pocket gophers are 5 to 14 inches long and have soft fur, ranging in color from black to varying shades of brown. Some species can be yellow to almost white.

Pocket gophers are well equipped for digging and tunneling. They have powerfully built forequarters; large-clawed front paws; fine, short fur that does not cake in wet soils; small eyes and ears; and flat heads and short necks. Gopher lips close behind four large incisor teeth to keep soil out of their mouths while digging, leaving their big, yellow incisors visible. Highly sensitive facial whiskers and tails help gophers move in the dark. The tail is sparsely covered with hair and has the unique function of helping to regulate body temperature. Gophers have a keen sense of smell, which enables them to find food.

Gophers become sexually mature at 1 year of age and can live for 3 to 5 years. Gophers breed in the spring



Figure 8. Pocket gopher. Photo by Glenn Shewmaker.

and produce one or two litters per year, averaging three to six young per litter. In irrigated alfalfa fields, it is not uncommon for gophers to have up to three litters per year. The gestation period is 20 days for most species. Births occur from March through June.

Pocket gopher behavior

Gophers do not hibernate and are active year-round. They are territorial and antisocial. There is normally only one gopher per burrow system, unless the gopher is mating or is a female raising a litter.

Gophers reside in varying geographical elevations, soils, and conditions. They will occupy rocky areas, but prefer fine-textured, deep, porous soils that are conducive to digging and feeding. Soils that do not hold tunnels (sandy soils) and

those that do not diffuse air for breathing (high-moisture, clay-based soil textures) limit populations. Deep soils are also important for insulating gophers from extreme temperatures. Vegetation with large, fleshy roots or tubers creates ideal habitat.

Burrows consist of a main tunnel and several lateral tunnels, which are linear or branched (Figures 9 and 10). Tunnels are about 2½ to 3½ inches in diameter. Tunnels always slope toward the ground surface because gophers do not make straight vertical tunnels.

A gopher's burrow system can cover an area that is 200 to 2,000 square feet. Typically, most feeding burrows are 6 inches or less below the soil surface. The nest and food storage chambers can be as deep as 6 feet.

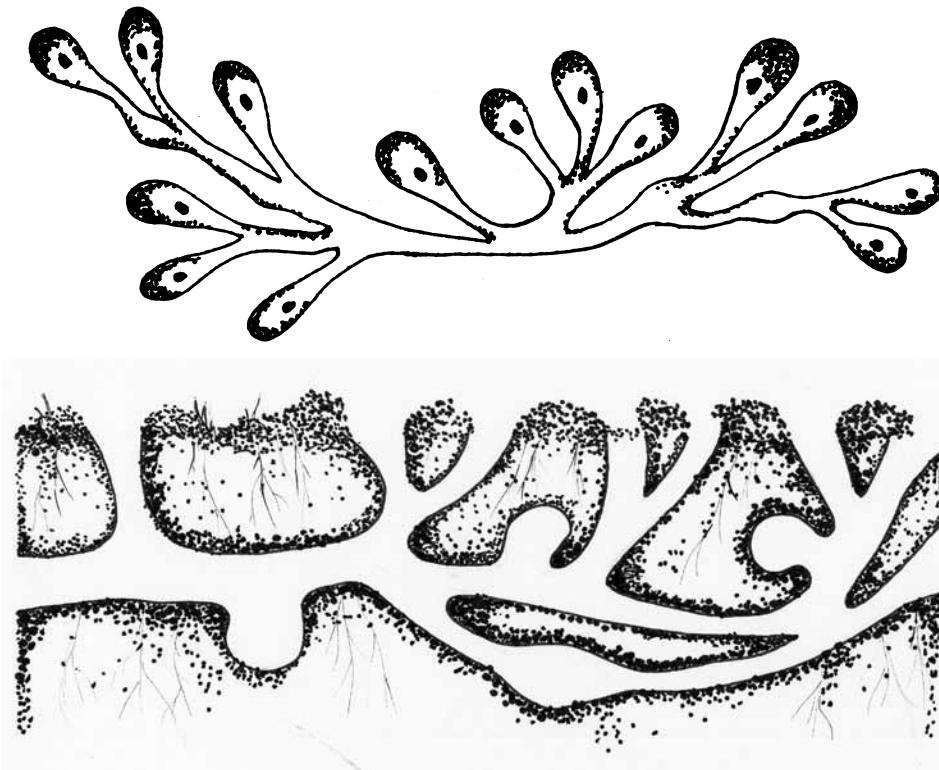

Figure 9. Gopher burrow system—top (above) and side (below) views. Drawing by Betsy Morishita.

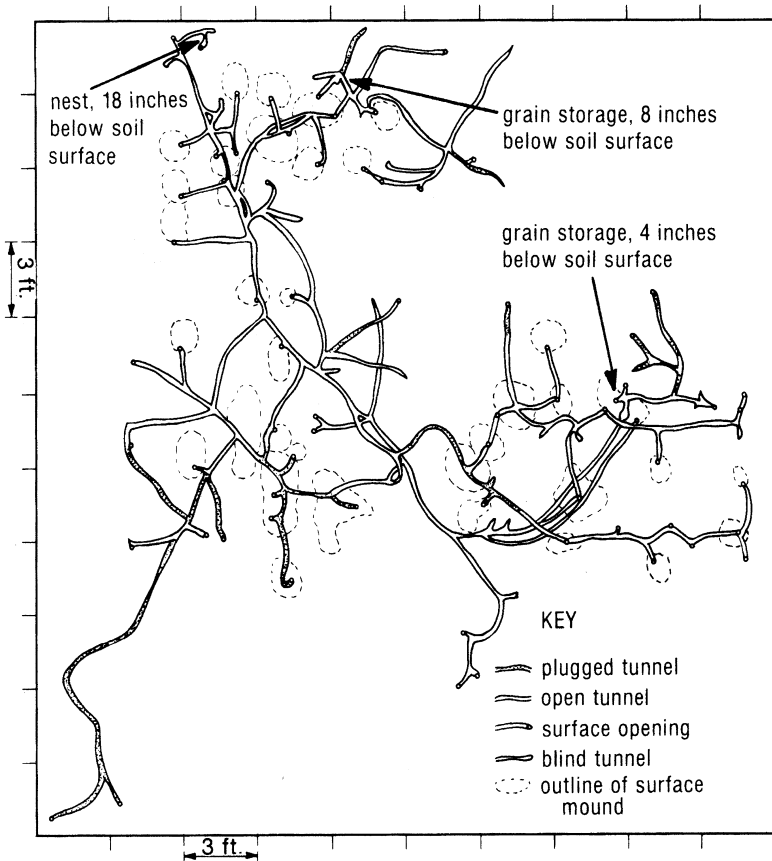

Figure 10. Underground view of a pocket gopher system. © Regents of the University of California. Reproduced by permission from Orloff, S., et al., eds. 1997. *Intermountain Alfalfa Management*. Publication 3366, University of California Division of Agriculture and Natural Resources.

As they dig tunnels, gophers push loose soil to the surface, forming mounds that are 12 to 18 inches wide and 4 to 6 inches high. Typically, mounds are crescent- or horseshoe-shaped when viewed from above. These soil deposits are plugged lateral tunnels. A slight depression will be present on the plug side of the mound (Figure 11). Gophers can create several mounds in one day. Fresh soil mounds are evidence of recent activity.

For the most part, gophers remain underground, although they are sometimes seen feeding at the edge of an open burrow, pushing soil out of a burrow, or moving to a new area. Gophers rarely venture more than 2½ feet from a burrow entrance.

Gophers feed underground on roots and tubers, and they cut plant stems below ground to pull plants into the burrow (Figure 12). They acquire water from the vegetation they feed on and do not need to leave the burrow to drink. Gophers will consume any edible plant material, including green, succulent vegetation; roots; bulbs and tubers; grasses and seeds; forbs; tree roots and bark; and legumes with palatable roots, such as alfalfa and clovers. Annual crops, such as grains and annual grasses, are not ideal habitat for gophers because their shallow, fibrous root system does not provide a good food source.

Alfalfa is one of the best food sources and habitat for pocket gophers. Gophers are very destructive to alfalfa fields, feeding on alfalfa taproots and killing the plants. Gopher damage to alfalfa is permanent and will continue to affect field productivity throughout the life of the stand.

In irrigated cropping systems, gophers can damage irrigation lines, divert water by burrowing through ditches and dikes, degrade canals and levees, and cause soil erosion problems and various structural failures.

Gophers can also be very destructive to tree nurseries, orchards, and vineyards, especially during the winter, when food sources are limited. Gophers will gnaw and feed on the bark around the base of trees, shrubs, and vines, especially when

there is snow cover. This damage will reduce plant health and may kill the plant.

The level of infestation required to produce economic damage depends on growing conditions, irrigation practices, and the type and economic value of the crop. In a high-value crop, as few as two gophers per acre can decrease yield and plant viability.

Pocket gopher management

Understanding pocket gopher habits, especially the burrow system, is the key to effective control. Management methods include trapping, hand or mechanical baiting, fumigation, combustion, cultivation, and crop rotation. For most effective control, use a combination of methods. In cases of heavy infestations, drag or harrow the field to eliminate mounds of soil and identify active burrows. See Table 2 for a summary of control measures.

Trapping

In Idaho and Oregon, trapping is legal and is a safe and effective control method for small areas or light infestations. It may not be practical or economical for large acreages or for heavy infestations. Trapping can be done year-round, but is difficult when the ground is frozen.

The most common type of trap is a two-pronged pincher trap. The trap is triggered when the gopher pushes against a flat, vertical pan. Examples include the Cinch, Macabee, and Gophinator (Figures 13–15) style traps.

Note: Trapping is not allowed in Washington State. Residents in Washington cannot utilize trapping to manage pocket gopher populations.



Figure 11. Fresh gopher mound. The depression in the mound indicates a plugged hole. Photo by Danielle Gunn



Figure 12. Gopher cache of beans. Photo by Glenn Shewmaker.

Table 2. Pocket gopher management options.

Control method	Rodenticide	Legal constraints*	Timing	Comments
Vegetation modification	n/a	n/a	Early spring through late fall	Mow, graze, or burn vegetation. Remove weeds and other debris.
Cultivation	n/a	n/a	Early spring through late fall	Cultivation destroys burrows and mounds.
Crop rotation to small grains	n/a	n/a	When possible	Gophers do not prefer the shallow roots of small grain crops.
Trapping	n/a	Trapping is not legal in Washington. May be used only in Idaho and Oregon.	Year-round	Time-consuming but effective. Use traps in pairs, facing opposite directions in the main burrow.
Hand and mechanical baiting	Strychnine	Cannot be used above ground.	Early spring through late fall	Very effective.
	Zinc phosphide	Check product labels for usage information. Some formulations are restricted-use products. Oregon has additional restrictions.	Early spring through late fall	Apply by hand for small infestations or mechanically for large infestations. Do not apply when moisture is anticipated.
Hand baiting	Rozol	For noncrop use only.	Early spring and late fall	Can be effective for small infestations.
Mechanical baiting	Rozol Gopher Bait Burrow Builder Formula	Restricted-use pesticide. Can be used in alfalfa.	Early spring and late fall	For use with artificial burrow builders. Can be very effective.
Exclusions: gravel, 1/2- to 3/8-inch wire mesh, metal, wires, and underground plastic pipes	n/a	n/a	Year-round	Helps protect ornamentals and underground structures.
Fumigation	n/a	Aluminum phosphide is a restricted-use product. Carbon-monoxide-producing devices are not restricted-use products.	Spring through late fall	Works best when soil is moist enough to maintain tunnel structure.
Combustion	n/a	n/a	Early spring through late fall	Use extreme caution with this method.

*Pesticide license requirements for baits and fumigants: Note that some baits and all aluminum phosphide fumigants are restricted-use pesticides (RUP) and can be purchased and applied only by a licensed pesticide applicator. Oregon has additional restrictions on zinc phosphide use. Contact your state department of agriculture for more information concerning pesticide licensing for rodent control.



Figure 13. Cinch Trap. (Note: Trapping is legal only in Idaho and Oregon, not in Washington.) Photo by Sherman Takatori.



Figure 14. Improved Cinch Trap. (Note: Trapping is legal only in Idaho and Oregon, not in Washington.) Photo by Sherman Takatori.



Figure 15. Macabee gopher trap. (Note: Trapping is legal only in Idaho and Oregon, not in Washington.) Photo by Sherman Takatori.

Another popular type is the choker-style box trap (Figure 16). Box traps are often easier to set, particularly for the beginning trapper. The Black Hole Trap is similar to a box trap, but is made with a plastic tube the same diameter as a gopher burrow. It uses a spring-loaded noose instead of the box trap's spring-loaded ridged wire mechanism to catch the gopher.

Generally, open-trigger style traps (box, Cinch, Gophinator) are better for lateral tunnels, and closed-trigger style traps (Macabee and the Victor Ring) are better for main burrows.

To begin trapping, locate areas of recent gopher activity based on the presence of fresh mounds of moist, dark soil. Mounds have a small, circular depression on one side, which is the plugged opening of a lateral tunnel. Gophers may not revisit lateral tunnels, so trapping and baiting may be more successful

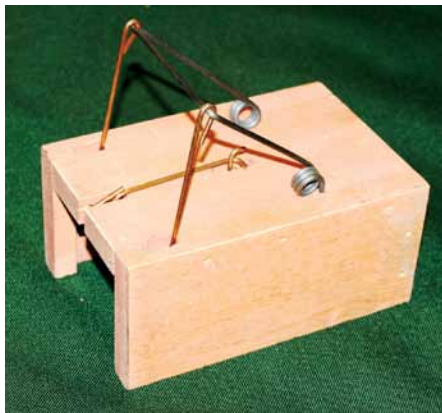

Figure 16. Box trap. (Note: Trapping is legal only in Idaho and Oregon, not in Washington.) Photo by Sherman Takatori.

in the main burrow. Beginning with a fresh mound, probe on the plug side of the mound with a gopher probe or by digging with a shovel. If using a shovel, dig into the lateral tunnel plug until it can be opened. Then follow this lateral to the main tunnel; it will intersect with the lateral burrow approximately 8 to 12 inches from the soil plug and will be 6 to 12 inches deep. Often, the main burrow goes between two lateral tunnels.

Gopher probes (Figure 17) can make it easier to locate the main tunnel. Probes can be purchased from farm supply stores or constructed with pipe. It takes some practice to recognize when the probe enters the main burrow. When it drops approximately 2 inches, you have located the main tunnel (Figure 18).

Although the main tunnel is generally the best place to trap, trapping in lateral tunnels may be effective if traps are placed where there is evidence of very recent activity. In fact, experienced gopher trappers report more success trapping in actively used laterals than in main burrows. Laterals are used for maintenance of the main burrow system, and gophers generally revisit a lateral a number of times to move soil and other materials to the surface.

One advantage of trapping in laterals is that less digging is needed. Trapping in main tunnels takes more time and significantly disturbs the burrow system. The gopher may become aware of this disturbance and shy away from the trap. Also, when trapping an active



Figure 18. Gopher probe in burrow. Photo by Glenn Shewmaker.



Figure 17. Gopher probe. Photo by Danielle Gunn.

lateral, there is no need to cover the opening, since gophers usually leave laterals unplugged.

Regardless of whether you trap in the main tunnel or in a lateral, use a shovel to open the tunnel wide enough to set traps. Place traps in pairs with their openings facing opposite directions (Figure 19) in order to intercept a gopher coming from either end of the burrow. Attach traps to stakes with wire to prevent gophers from moving them deep into the burrow system.

If trapping in main burrows, cover openings with plywood, soil clods, or other materials to exclude light. Gophers do not like openings in the main burrow system and will promptly cover the source of light or leave, thereby avoiding the trap. If trapping in lateral tunnels, it is not necessary to cover the opening.

Move traps approximately every 3 days.

Hand baiting

Bait must be placed in the main burrow where gophers are active. If bait is placed in lateral burrows, the gopher is more likely to push it up to the surface, increasing the chance of nontarget poisoning.

After locating the main gopher tunnel as described on page 11, enlarge the opening by rotating the probe or inserting a rod or stick into the opening. Place the bait carefully in the opening using a long-handled spoon or other suitable device. Take care not to spill bait onto the ground. Hand-held gopher-baiting equipment can be purchased from farm supply stores. These devices consist of a probe and a bait reser-

Note: See sidebar on page 6 for more information about using rodenticides.

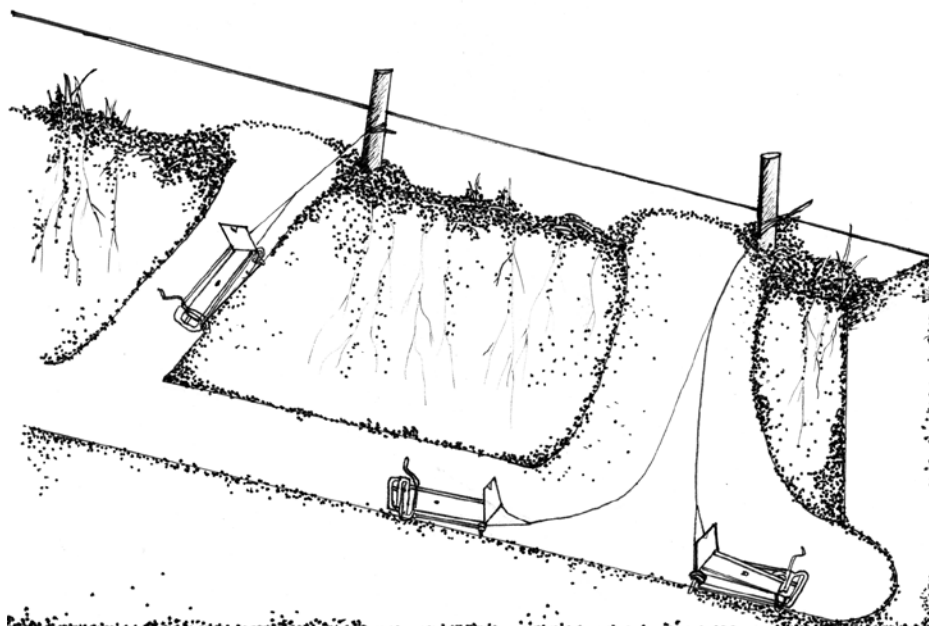

Figure 19. Proper trap placement in gopher tunnels. Note stakes for the traps. (Note: Trapping is legal only in Idaho and Oregon, not in Washington.) Drawing by Betsy Morishita.

voir (Figure 20). Use the device to probe for the gopher burrow and place a premeasured amount of bait in the burrow by turning or depressing a lever.

Place the bait in the main tunnel in two or three locations. Close the probe holes with plywood, rocks, soil clods, or any other material that will exclude light and protect the bait. Make sure to prevent dirt from falling on the bait. Do not reuse the bait placement device for any other purpose.

After placing bait, use a shovel or spade to knock down or level existing gopher mounds. This will make it easier to identify new gopher activity and retreat as necessary.

Rodenticide bait rates vary depending on the product type, location of use, and application method. Check the product label for rates.

Strychnine: Strychnine is the most common type of toxic bait utilized for control of small gopher infestations in lawns and agricultural fields. It can be used only below ground. Strychnine baits are sold



Figure 20. Hand-held gopher baiting apparatus. Photo by Danielle Gunn.

under many trade names, and most contain 0.5 percent strychnine. Contact your local extension office for information on these products.

Strychnine is lethal in a single feeding. Strychnine accumulates in body tissues; therefore, if a pet or other animal ingests a gopher poisoned with strychnine, immediate death can result. Pick up and dispose of spilled bait according to label instructions.

Zinc phosphide: Several zinc phosphide products are available. Check labels to be sure you select a product suitable for your needs. ZP Rodent Bait is labeled only for underground applications in rangeland, cropland, forest areas, parks, nurseries, lawns, golf courses, and around homes. Other zinc phosphide products can be used only on lawns, golf courses, and other noncrop areas.

The State of Oregon may have additional restrictions on the use of zinc phosphide for pocket gopher control. Oregon has several Special Local Need (SLN) labels for the use of zinc phosphide. (See the sidebar on page 5 for more information.) Be sure to check with the Oregon State Department of Agriculture or their website (<http://www.oregon.gov/ODA/PEST/index.shtml>) before purchasing or applying any zinc phosphide in Oregon, and read and follow all zinc phosphide use directions on the Oregon SLN labels.

Anticoagulants: Anticoagulant baits are generally less effective than strychnine baits but are less toxic. Their lower toxicity makes them a better choice in areas where pets or other domestic animals might uncover the bait through digging. These products are multiple-feed baits and require more bait per ap-

plication than single-feed baits such as strychnine.

Anticoagulant baits contain diphacinone (Kaput D, Gopher Whacker, and Answer) or chlorophacinone (Rozol). Diphacinone bait products can be used only on lawns, golf courses, rangeland, and other noncrop areas.

Note: See sidebar on page 6 for more information about using rodenticides.

Mechanical baiting

Burrow builders (Figures 21 and 22) are an effective, time-saving method of baiting in large areas with significant numbers of gophers. Burrow builders can be connected to a three-point tractor hitch. With this system, a tube or “torpedo” and colter cuts the soil and makes artificial burrows, a seeder or granular applicator dispenses bait into the artificial burrow at specific intervals, and a packer wheel closes the furrow. Gophers will explore the new

Figure 21. Burrow builder applicator. Photo by Glenn Shewmaker.



Figure 22. Burrow builder applicator. Photo by Glenn Shewmaker.



burrows, increasing their potential for bait consumption.

Baiting artificial burrows will not prevent gopher infestations. Use the machine only where gophers are present. Treat the perimeters of fields to delay reinvasion.

Use of a burrow builder requires significant knowledge. Consult the manufacturer or a knowledgeable person about proper use.

Before using a burrow builder, dig around fresh gopher mounds to determine the depth of the main tunnels and the soil conditions in the field. The burrow builder must be set at the same depth and perpendicular to existing burrows. Dig burrows 20 to 30 feet apart. Soil moisture must be adequate so the soil will hold the burrows. When crossing uninfested areas, raise the shank to avoid making burrows; gophers will invade a previously

uninfested area to explore artificial burrows.

When applying bait, check frequently to ensure that tunnels are developing properly and that the bait dispenser is working properly.

Strychnine is the most common type of bait used with burrow builders. Rozol Pocket Gopher Bait-Burrow Builder Formula (chlorophacinone) is also approved for use on alfalfa and rangeland, in orchards and groves, and noncrop areas in Idaho, Oregon, and Washington (EPA Reg. No. 7173-244) with burrow builders. It is a restricted-use pesticide, requiring a pesticide applicator license to purchase and apply. Apply this product when soil conditions allow formation of good artificial burrows.

Always read label instructions when applying any bait. Be sure to pick up spilled bait and dispose of it according to label instructions.

Fumigation

Fumigation with lethal gases, such as aluminum phosphide and carbon monoxide, can be a cost-effective method of gopher control. Machines are available that make and distribute gases throughout the burrow system.

Carbon monoxide-producing devices do not require a pesticide applicator license to purchase and use. Aluminum phosphide is a restricted-use product and requires a pesticide applicator license to purchase and use.

Carbon monoxide is odorless, but the methods used to produce it sometimes give off odors. Nonetheless, these odors do not seem to alert gophers to danger, so they do not attempt to seal holes in the tunnel or try to escape. Aluminum phosphide emits an odor, but it does not seem to alarm gophers.

Figure 23. Gopher control in a large infestation using the Rodenator. The Rodenator uses a mixture of oxygen and propane to kill gophers and collapse tunnel systems. Photo reproduced courtesy of Meyer Industries, Emmett, Idaho.



When using aluminum phosphide, it is very important to treat each burrow system at three different locations. This will provide adequate gas dispersion throughout the burrow system. **DO NOT** add water to aluminum phosphide tablets or pellets in order to liberate the phosphine gas faster. The rapid release of gas could create a hazardous situation for the applicator.

Combustion

A mixture of propane (or other explosive gas) and oxygen (Figures 23 and 24) can be very effective. The gases are forced into the burrow system and ignited. The combustion kills the gopher and collapses the burrow. Collapsing the burrow or a portion of the burrow reduces the chance that another gopher will re-inhabit the burrow system.

The explosive gas is used in a very low concentration relative to the oxygen mix, but gophers do seem to avoid the gas mixture due to the odor.

Gas cartridges are available, but they are costly and time-consuming to use and give varying results. Because gopher tunnels are extensive, gas may not disperse through the entire system. Gophers may smell the gas and plug the tunnel before it can reach them. Wet soils inhibit gas dispersal. Because of their higher cost and inconsistent effectiveness, gas cartridges are not recommended.

Using combustion for gopher control can be hazardous to the applicator and must be done with extreme caution.

Cultivation

Tilling, disking, and plowing can inhibit gopher activity. Cultivation destroys burrows and mounds and may drive gophers to other locations.



Figure 24. Use of the Rodenator to control gophers. Photo reproduced courtesy of Meyer Industries, Emmett, Idaho.

Crop rotation

Rotating alfalfa and pasture to small grains can be a very effective control measure. Small grains have small, fibrous root systems that do not sustain gophers as well as fleshy, tap-rooted vegetation such as alfalfa.

Growing a buffer strip of small grains around alfalfa and pastures can discourage large gopher populations. Buffer strips are particularly beneficial if the field is adjacent to an area with a known infestation or to land where gophers can't be controlled, such as state or federal land. Buffer strips should be approximately 50 feet wide.

Some growers feel that buffer strips this large are not practical for perennial crop protection since they take land out of production. However, the purpose of the buffer is to protect the crop from heavy infestations that could be economically damaging. If gopher infestations are

particularly high, temporary buffer strips might be an economically viable option.

Predators

Predators that feed on gophers include owls, hawks, badgers, coyotes, foxes, bobcats, skunks, weasels, bull snakes, and rattlesnakes. However, these predators do not effectively control large populations.

Other options

Fences can protect ornamental shrubs and trees. To protect flower beds and vegetable gardens, bury 1/2- to 3/8-inch mesh wire 2 feet deep, leaving 1 foot extending above ground. Lay gravel around cables and encase sprinkler lines in metal for protection.

Further readings

- Andelt, W.F. and R.M. Case. 2006. *Managing Pocket Gophers*. Natural Resources Series No. 6515, Colorado State University Extension. <http://www.ext.colostate.edu/pubs/natres/06515.html>
- Case, R.M. and B.A. Jasch. 1994. *Pocket Gophers: Prevention and Control of Wildlife Damage*. University of Nebraska Lincoln—Extension. <http://icwdm.org/handbook/rodents/pocketgophers.asp>
- O'Brien, J.M. 1994. *Voles: Prevention and Control of Wildlife Damage*. University of Nebraska Lincoln—Extension. <http://icwdm.org/handbook/rodents/voles.asp>
- Orloff, S.B., T.P. Salmon, and W.P. Gorenzel. 1997. Vertebrate Pests (Chapter 10), pp. 85–92. In: *Intermountain Alfalfa Management*, S.B Orloff, H.L. Carlson, and L.R. Teuber (eds.), Publication 3366, University of California, Division of Agriculture and Natural Resources.
- Salmon, T.P. and W.P. Gorenzel. 2010. *Voles (Meadow Mice)*. Pest Notes Publication 7439, University of California, Division of Agriculture and Natural Resources. <http://www.ipm.ucdavis.edu>
- Takatori, S. 2010. Idaho State Department of Agriculture Pesticide Updates.
- Thaemert, R. 2006. Rodent Control. pp. 63–65. In: *Proceedings, Idaho Alfalfa and Forage Conference*, February 27–28. Twin Falls, Idaho. University of Idaho Cooperative Extension. <http://www.extension.uidaho.edu/forage/Proceedings/2006%20PDF/Thaemert%20rodent%20control%20.pdf>

Vantassel, S.M., S.W. Hygnstrom, D.M. Ferraro, and B.E. Anderson. 2009. Publication G1509, *Controlling Pocket Gophers in Nebraska*. University of Nebraska Lincoln—Extension. <http://www.ianrpubs.unl.edu/sendIt/g1509.pdf>

Whitaker, J.O. 1996. *National Audubon Society Field Guide to North American Mammals*. Alfred A. Knopf, Inc., New York (11th printing, 2007).

The Authors

Danielle Gunn, University of Idaho Agricultural Extension Educator, Fort Hall

Ronda Hirnyck, University of Idaho Extension Pesticide Coordinator

Glenn Shewmaker, University of Idaho Extension Forage Specialist

Sherman Takatori, Program Manager, Idaho State Department of Agriculture

Lance T. Ellis, University of Idaho Extension Educator, Fremont County

ALWAYS read and follow the instructions printed on the pesticide label. The pesticide recommendations in this publication do not substitute for instructions on the label. Pesticide laws and labels change frequently and may have changed since this publication was written. Some pesticides may have been withdrawn or had certain uses prohibited. Use pesticides with care. Do not use a pesticide unless the specific plant, animal, or other application site is specifically listed on the label. Store pesticides in their original containers and keep them out of the reach of children, pets, and livestock.

Trade Names—To simplify information, trade names have been used. No endorsement of named products is intended nor is criticism implied of similar products not mentioned.

Groundwater—To protect groundwater, when there is a choice of pesticides, the applicator should use the product least likely to leach.

Pacific Northwest extension publications are produced cooperatively by the three Pacific Northwest land-grant universities: Washington State University, Oregon State University, and the University of Idaho. Similar crops, climate, and topography create a natural geographic unit that crosses state lines. Since 1949, the PNW program has published more than 600 titles, preventing duplication of effort, broadening the availability of faculty specialists, and substantially reducing costs for the participating states.

Published and distributed in furtherance of the Acts of Congress of May 8 and June 30, 1914, by University of Idaho Extension, the Oregon State University Extension Service, Washington State University Extension, and the U.S. Department of Agriculture cooperating.

The three participating extension services offer educational programs, activities, and materials without regard to race, color, national origin, religion, sex, sexual orientation, age, disability, or status as a disabled veteran or Vietnam-era veteran, as required by state and federal laws. University of Idaho Extension, Oregon State University Extension Service, and Washington State University Extension are Equal Opportunity Employers.